



UPVC WINDOW & DOOR PROFILE

www.cfour-profile.com



Fanavar Plastic Sepahan corporation (F.P.S Co)

It has been established in Najaf Abad industrial zone in 2005, with the aim of manufacturing PVC, UPVC and WPC building components. Currently we operate more than 120,000 square meters manufacturing facilities using the largest extrusion lines and known as one of the leading producer in the field of polymer constructional parts in the country. One of the most prominent products of this complex are UPVC doors and windows profile in white and other colors called C-Four.

ABOUT US

F.P.S.CO has always been ahead of the building products industry in the country. As the leading building solutions provider which has been committed to quality and innovation, we distribute various upvc products by providing our 4 brands such as vinyl siding and accessories (C.PAN SIDING), window and door profile (C.FOUR), indoor siding panels and ceiling (C.PAN) and wood polymer doors (C.DOOR).

www.cdoor.ir

www.cpan-panel.com

www.cfour-profile.com

www.fanavarplastic.com





INNOVATION & TECHNOLOGY

Our production plants are equipped with advanced extruders, calibrators, automatic mixing equipment, tank plates and cooling tanks, apart of extrusion lines, we use an unique exclusive technology called **HOTMELT TECH[®]** to produce wood and metallic colored finish profiles. With our experienced team of engineers and devoted workforce C.FOUR is well known for it's high quality and responding to changes in market requirements.

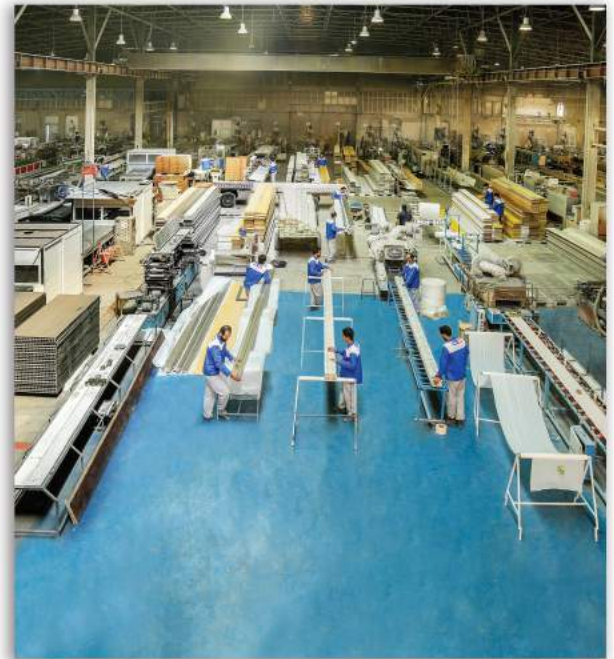

QUALITY CONTROL AND TESTING

One of our key features at C.FOUR is testing to ensure maintaining fine quality. In our advanced laboratory following aspects are checked:

- Material
- Appearance
- dimensions and tolerances
- mass of main profiles
- heat reversion
- resistance to impact of main profiles by falling mass
- behaviour after heating at 150 c
- resistance to weathering and weldability



HOTMELT TECH[®]

F.P.S.CO aims to create world class products to evolutionized the construction and renovation industry by introducing its high quality and game-changing upvc products and technologies.

As a market leader in upvc profile industry C.four provides customized solutions and unique technology designed to meet your expectations and suit any harsh environmental conditions.



HOTMELT TECH[®] is the result of years of research and studying of our experienced R&D team and innovative engineering which is exclusive. with it`s special coating layer on profiles that make c.four profiles fade resistance and give them more appealing look; c.four profile is a reasonable choice for replacement of laminated ones in matter of quality and even price.



A Z T E S T

arizona desert testing LLC

Arizona Desert Testing LLC (AZTEST) is a materials testing laboratory that specializes in accelerated and outdoor weathering services.

testing is performed in the Arizona desert — an ideal environment for weathering studies. Blistering heat, extreme aridity and near-constant sunshine combine to create a virtually unmatched outdoor laboratory for benchmarking product durability under harsh conditions.

the laboratory is accredited by A2LA to ISO 17025 requirements. Arizona Desert Testing is also accredited by AMECA (Automotive Manufacturers Equipment Compliance Agency) for weathering services in accordance with SAE J576.

FSP co always been extremely committed to research and development. therefore for the first time in country C.FOUR colored profiles had sent to United States of America to get tested for color fading and withstanding the weathering effects of desert conditions ensuring they long lasting beauty and they passed the test.

AZTEST	YSC-1 May 7, 2019 1:23:57 PM MST
Weathering Test Report - Interim YSC-1	
<small>The data contained in this report is representative of the materials or specimens provided by the client. Arizona Desert Testing LLC makes no representations that the material or specimens tested relate to any other batch or lot. This report shall not be reproduced except in full, without the written permission of Arizona Desert Testing LLC.</small>	
<small>The information contained in this electronic test report is privileged and confidential information intended for the use of the addressee listed above. If you are neither the intended recipient nor the employee or agent responsible for delivering this message to the intended recipient, you are hereby notified that any disclosure, copying, distribution or the taking of any action reliance on the contents of the message is strictly prohibited. If you have obtained this test report in error, please immediately notify AZTEST by telephone to arrange for return of the original document to us.</small>	
Test Summary	
Conducted For:	Hamid Moradi
Submitted By:	Sahel Youzefi 11740 Wilshire Blvd. Los Angeles, CA 90025 USA
Performed By:	Arizona Desert Testing, LLC 21212 West Patton Road Wittmann, AZ 85361 USA
Approved By:	Bill Putman 623-388-8500 x16
AZTest Test #:	YSC-1
Client Reference #:	AZT#7546
Description:	ASTM G90 Cycle 1 Testing 5 panels
Duration:	1,000 UV MJ/m2
Started On:	11/06/18
Status:	Samples 1, 2: On Exposure with 608 UV MJ/m2 as of 05/07/19 1:00PM MST
<small>Page 1 of 4</small>	



White



Oak



Dark Walnut



Light Silver



Dark Silver



Metallic Champagne

A PERFECT FINISH TO YOUR HOME

C.FOUR dual-color with white color for interior and different colors for external parts of door and window offer you many color options & combinations to Make a statement and curb appealing look for outside of your home.

white applied to the internal framework ensures that the interior of your home will look bright and fresh while our range of colors for the exterior will feel instantly more sophisticated.



COLORS THAT CAPTIVATE!

Our coloured profiles are extremely durable and easy to clean making them the perfect choice to help your new window and door blend effortlessly into your home.



C.FOUR CASEMENT SYSTEM

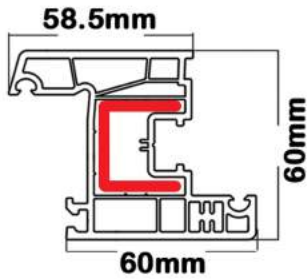

Window Sash profile

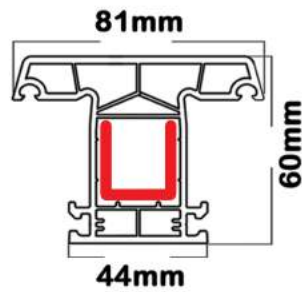

Mullion profile

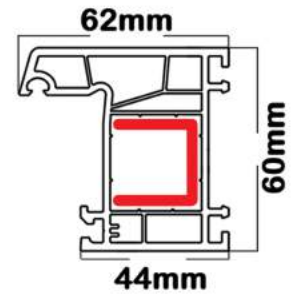

Frame profile

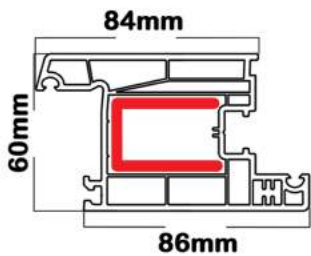

Door Sash profile

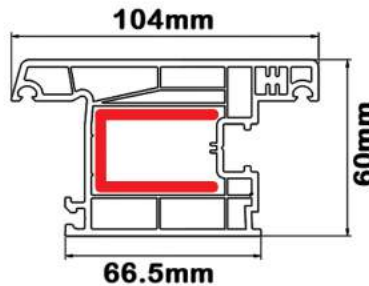

Door sash outward open profile

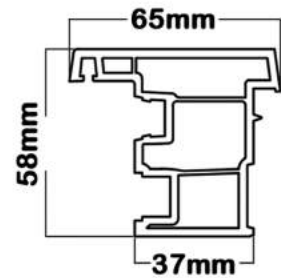

Lap joint profile

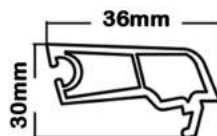

Single glazing bead

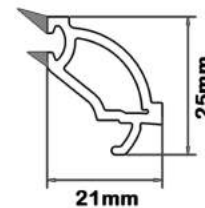

Double glazing bead

C.FOUR SLIDING SYSTEM

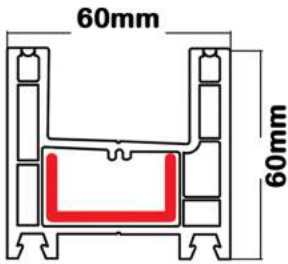

2 track sliding frame profile

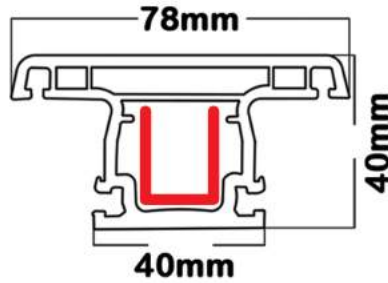

Sliding mullion profile

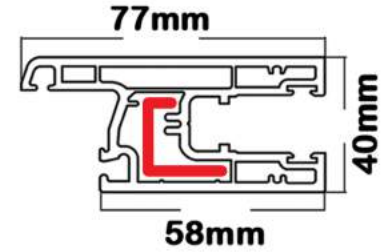

Sliding window sash profile

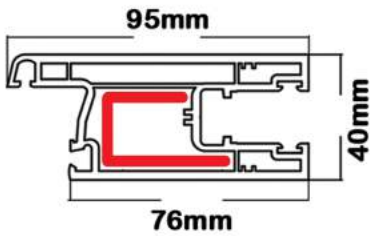

Sliding door sash Profile

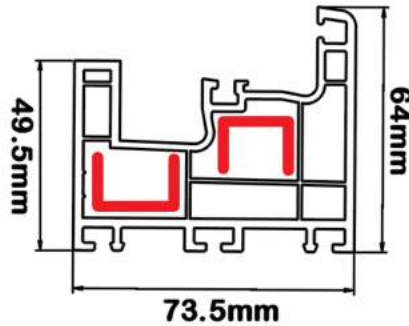

Mono rail frame profile

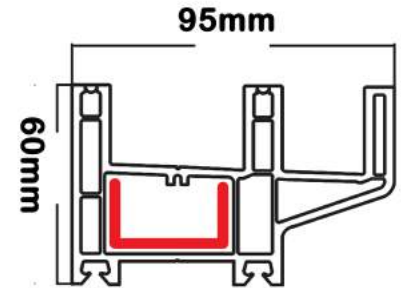

3 track sliding frame profile

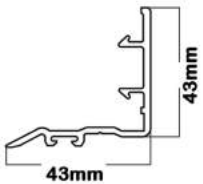

Sliding window interlock

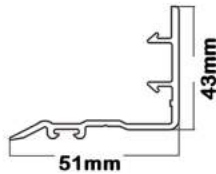

Sliding door interlock

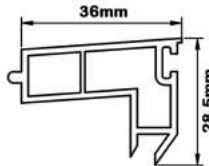

Mono rail cover profile

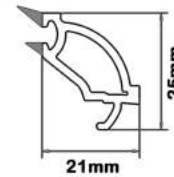

Single glazing bead



Double glazing bead

C.FOUR ANCILLARY

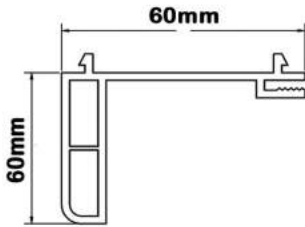

Renovation frame model profile

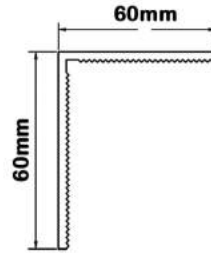

Renovation frame profile

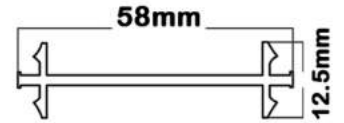

Coupling profile



Pipe profile

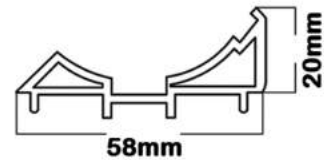

Pipe adaptor profile

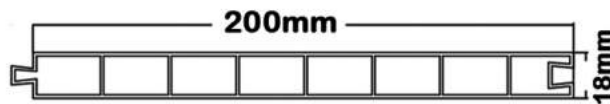

Door panel profile

PRODUCT'S FEATURES

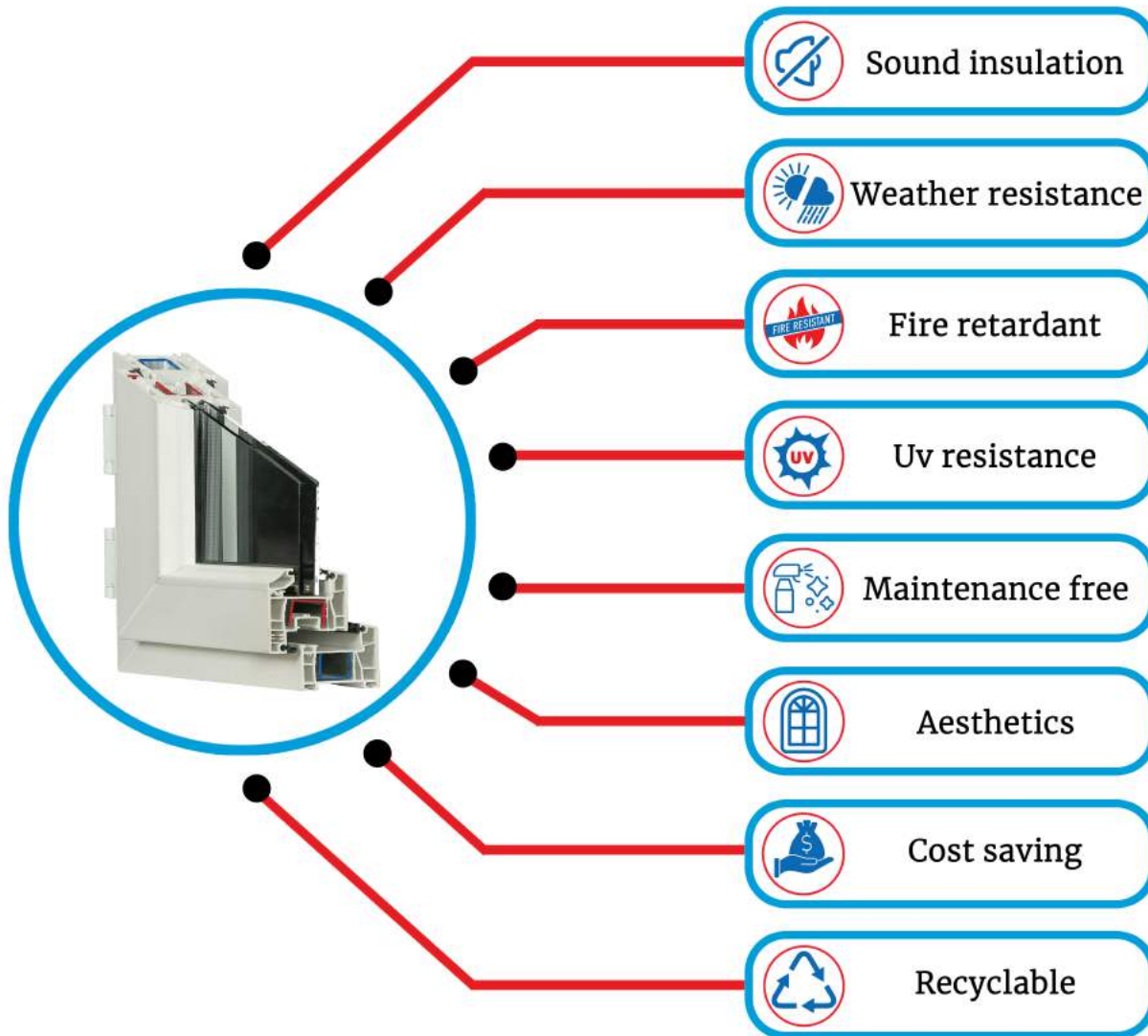

OUR PROJECTS



OUR PROJECTS

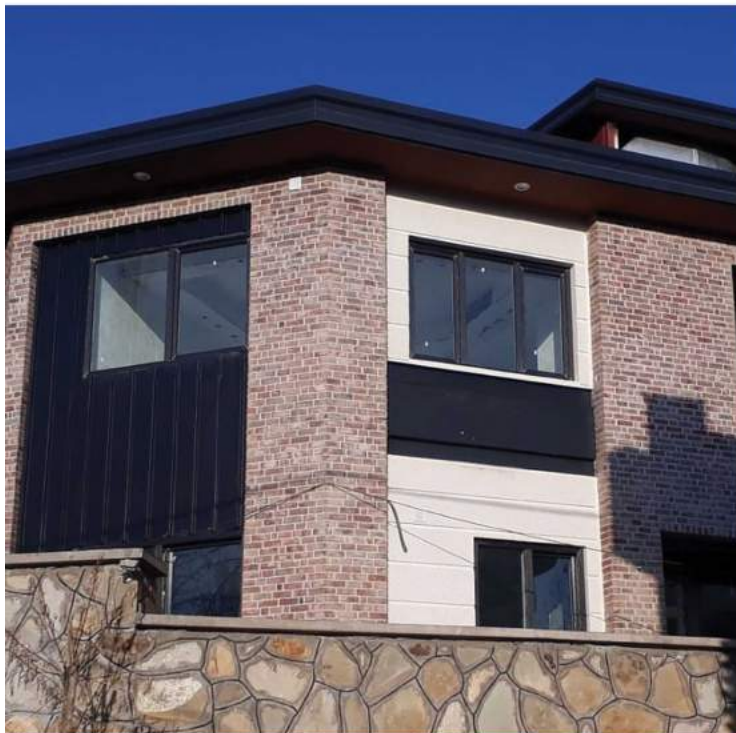

SOME OF OUR AWARDS AND HONORS



- Top Isfahan Province Exporter 2020 ,2018 ,2017 ,2015 ,2014
- Top Isfahan Province Entrepreneur 2015 , 2014
- Top Iran Entrepreneur 2012
- Iran Industrial Elite 2016
- Top Iran Exporter 2016
- ...

CONTACT US



Sales Office : Second floor, Gazsozan building, near 15th Shaghayegh st.-
Vahid bridge, Isfahan, IRAN



+9831 - 33339999

+98916 - 231 - 3109



www.cfour-profile.com



[cfour.fps](https://www.instagram.com/cfour.fps)